

Product Information

Product Type	Tamper-Evident
Shape	Round
Volume	210ml
Container Diameter	95.8mm
Container Height	46.85mm
Container Weight	10.7g
Lid Weight	5g
Colour	Clear
Food Approval	Yes
Closure Type	Tamper-Evident Tab
Protective Collar	Yes
Handle Available?	No
IML Available?	Container and Lid



Technical Specification

Materials	PP random QU 80 A (MFI 35), Braskem (MFI 40), Borealis RJ377MO Random, Moplen RP348T, Borealis BD950MO Freezgrade (Transparent).
Approval	All raw materials and masterbatches used in the production process have the appropriate food contact
Colours	Preferred colours: White 101, Clear, Natural, Blue 201, Dark Blue 204, Black 601, Light Grey 502, Red 331, Yellow 430 and Green 803. Additional colours: Transparent Red 338, Silver 521, Gold 21720, Warm Red 307, Warm Yellow 417, Beige 421, Brown 901, Dark Grey 501 (metal grey), Orange 741 and Blue 213. All other colours on request.
Hot Fill	85–95° C The material chosen has a very good heat resistance and the packaging is suitable for hot filling. Notably, plastic packaging become flexible when subjected to hot filling temperatures and care must be taken in relation to stacking immediately after hot filling. After cooling of the product and pail, the pail regains its original stacking strength. Microwave Safe
Cold Temperatures	The standard resin material for white/coloured products resists temperatures down to -20° C. Deep freezing below - 20° C may require a special resin available on request. Standard transparent (CLX) products might become brittle at temperatures below 0° C, and special resins are available on request for applications below freezing. Resins tailored for freezing stability has a lower stackability than standard resin which must be taken into consideration.
Storage	The compliance of the product to the technical specifications in this data sheet is guaranteed for 12 months after the date of the delivery subject to suitable storage.

Palletisation

Item	Pieces per Box	Pieces per Pallet	Boxes per Pallet	Box Size (CM)	Total Pallet Height (CM)
Containers and Lids	500	10000	20	H 40 x W 40 x L 60	215
Containers	648	12960	20	Same as Above	215
Lids	2280	45600	20	Same as Above	215

Technical Drawings

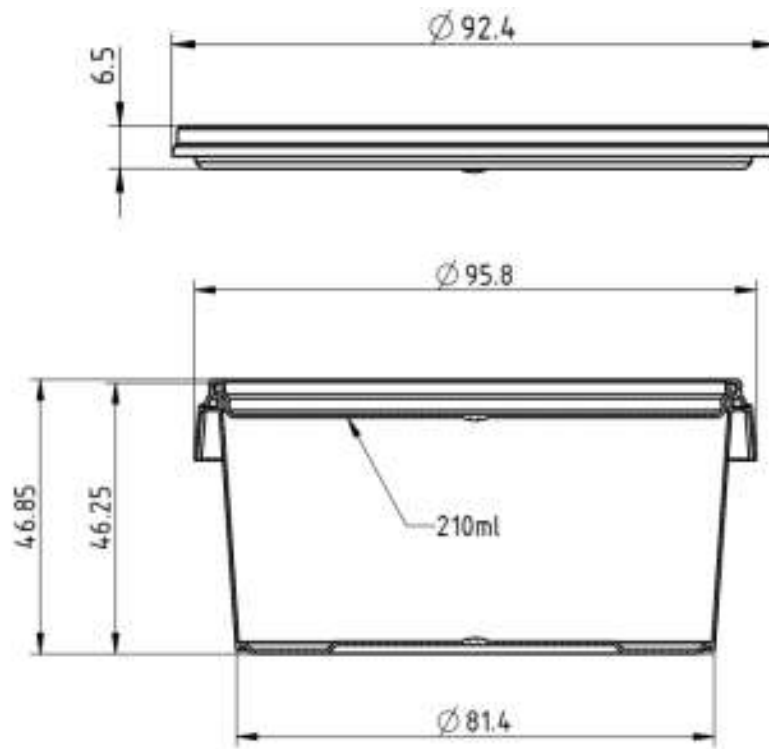

Technical Label Specifications

